

## POSTE CÓNICO DE 8 M GALVANIZADO

0.732M



**PERCHA**



**POSTE CONICO DE 8M CAL 11 PESO 84.71 KG**



0.305

**ARILLO**

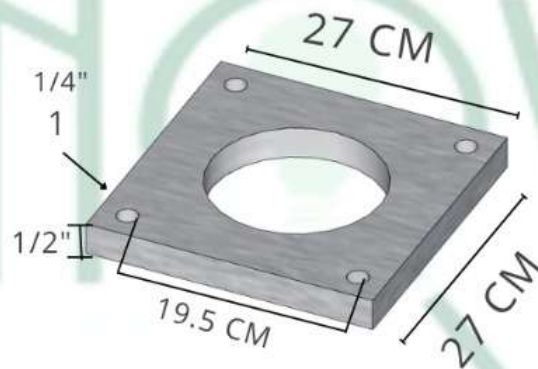

**PLACA BASE DE 0.27 X 0.27 M**

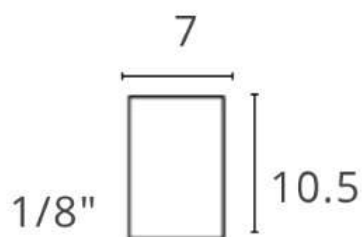

**REGISTRO DE 7X10.5**

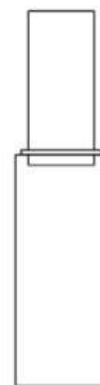

**ESPIGA**

8M

